

Data sheet

Patch cord Cat.6_A AWG 26 3.0 m red

Page 1/6

P/N

1308453066-E

EAN 4250184117735

2017-16-08

Illustrations



Dimensional drawing

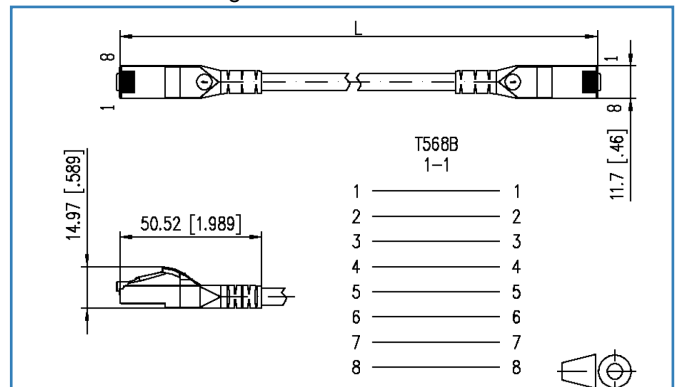

See enlarged drawings at the end of document



Product specification

- especially suitable for shielded and unshielded class E_A systems
- fully shielded Cat.6_A patch cord AWG 26/7
- two shielded RJ45 connectors; 1:1 assignment
- cable type: S/FTP 4x2xAWG 26/7 PIMF
- cable sheath: LSHF(LSOH), halogen free
- Cat.6_A to ISO/IEC 11801 Ed.2.2 (2011-06) and IEC 61935-2 Ed. 3.0 (2010-07), certified to GHMT
- class E_A Link up to 500 MHz to ISO/IEC 11801 Ed.2.2:2011-06, DIN EN 50173-1:2011-09
- suitable for 10 GBit Ethernet (IEEE 802.3an) and Remote Powering (PoE, PoE plus and UPoE) and HDBaseT
- snagless boot with integrated lever protection
- colors may differ slightly due to different protection lots

Technical Data

General Data

Fields of application	Office
Design	Patch cords
Shielding	shielded
Transmission technology	Copper
Cable Type	S/FTP
Number of twisting elements	4
Twisting element	Pair
Wiring	1 - 1
Color	red
Dimensions	
Dimension - Interface 1 (L x W x H)	50.52 x 11.70 x 14.97 mm
Dimension - Interface 1 (L x W x H)	1.989 x 0.461 x 0.589 in.
Dimension - Interface 2 (L x W x H)	50.52 x 11.70 x 14.97 mm
Dimension - Interface 2 (L x W x H)	1.989 x 0.461 x 0.589 in.
Cable length (m)	3.00 m
Cable length (ft)	9.84 ft
Marking option	by cable boot

Transmission characteristics

Category (ISO)	6 _A
Class (ISO/IEC)	E _A
Category (TIA)	6A
Remote Powering	yes
PoE	IEEE 802.3af
PoE plus	IEEE 802.3at
UPoE	yes
HDBaseT	yes
Transmission rate up to 10 GBit	IEEE 802.3an



Technical Data

Connections/interfaces

Connector technology interface 1	RJ45 plug
Connector technology interface 2	RJ45 plug
Number of ports interface 1	1
Number of ports interface 2	1
Number of equipped ports interface 1	1
Number of ports interface 2 equipped	1
Number of positions/contacts interface 1	8P/8C
Number of positions/contacts interface 2	8P/8C
Termination data, stranded wire (min. - max.)	
Conductor cross section, stranded wire	AWG 26/7
Conductor cross section, stranded wire	0.141 mm ²
Conductor diameter, stranded wire (bare copper)	0.483 mm
Conductor diameter, stranded wire (bare copper)	0.019 in.

Electrical characteristics

Current carrying capacity	max. 1 A
Rated voltage	max. 50 V
Contact resistance	max. 20 mOhm
Through resistance	max. 200 mOhm
Insulation resistance	min. 100 MOhm
Dielectric strength conductor-conductor (primarily)	max. 500 V DC
Dielectric strength conductor-conductor (secondary)	max. 500 V DC

Mechanical characteristics

Position/mounting of latch - standard installation position	top
---	-----

Materials and material properties

Material - Cable jacket	LSHF (LSOH)
Material - Plug housing interface 1	PC (polycarbonate)
Material - Plug housing interface 2	PC (polycarbonate)
Material - Contact interface 1	CuSn (tin bronze)
Material - Contact interface 2	CuSn (tin bronze)
Material - Contact finish interface 1	Au (gold)
Material - Contact finish interface 2	Au (gold)

Technical Data

Materials and material properties

Material - Contact carriers interface 1	Plastics
Material - Contact carriers interface 2	Plastics
Material - Shield interface 1	CuSn (tin bronze)
Material - Shield interface 2	CuSn (tin bronze)
Material - Shield finish interface 1	Sn (tin)
Material - Shield finish interface 2	Sn (tin)
Halogen free	yes

Environmental conditions

Temperature (min. - max.)	
Temperature - Storage °C	-20 - 60 °C
Temperature - Storage °F	-4 - 140 °F
Temperature - Operating °C	-20 - 60 °C
Temperature - Operating °F	-4 - 140 °F
Temperature - Installation °C	0 - 50 °C
Temperature - Installation °F	32 - 122 °F

Certifications

GHMT Component



GHMT component - Validity period 31.03.2017

Approvals

RoHS compliant

The product meets the following standards

Generic cabling systems	
General requirements	ISO/IEC 11801 Ed.2.2: 2011-06 DIN EN 50173-1: 2011-09 TIA/EIA 568-C.2
Connectors for electronic equipment	
Free and fixed connectors	IEC 60603-7-51
Information technology equipment - Radio disturbance characteristics	
	DIN EN 55022



Technical Data

The product meets the following standards

Specification for the testing of balanced and coaxial information technology cabling

Cords as specified in ISO/IEC 11801 and related standards	IEC 61935-2 Ed. 3.0 (2010-07)
---	-------------------------------

Classifications

ETIM 5.0	EC001262
ETIM 6.0	EC001262

Packing details

Type of packaging	1 pc(s) / plastic bag
Packaging unit - Weight (gram)	140.00 g
Packaging unit - Weight (pound)	0.31 lb



Illustrations

Dimensional drawing

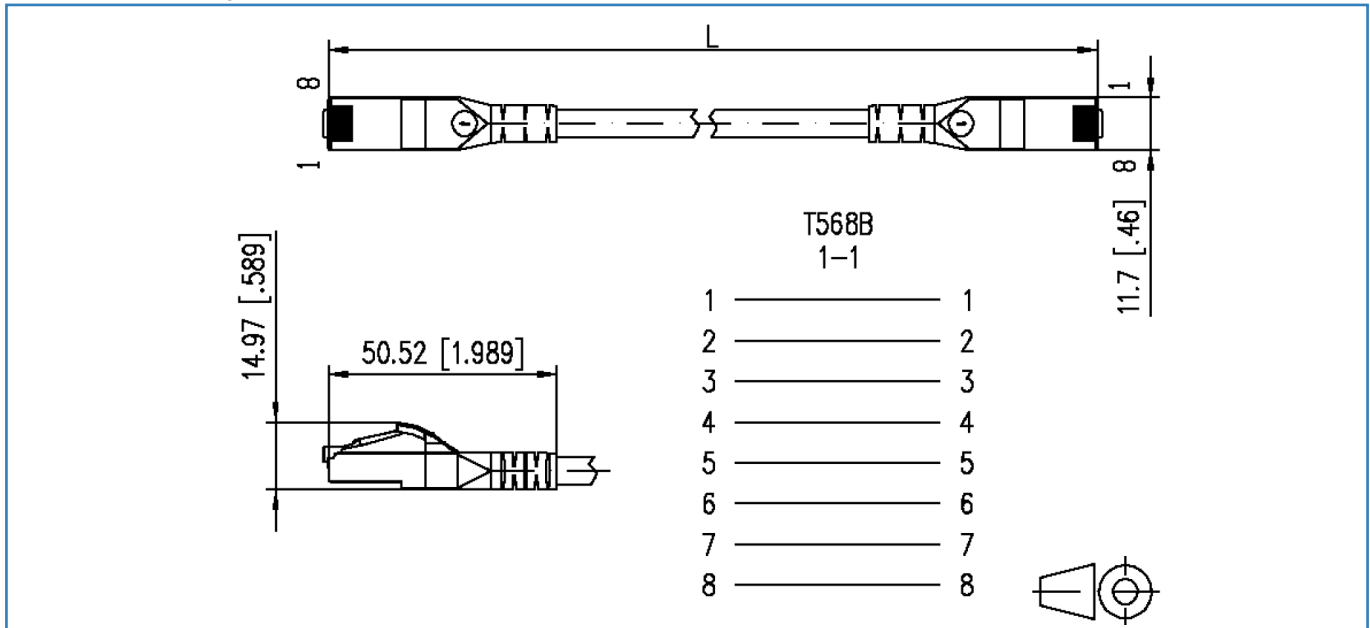

© 2017 METZ CONNECT - Technische Änderungen vorbehalten! Subject to modifications! Sous réserve de modifications techniques!

