

Data sheet

PM PCC OpDAT patch cord LC-D/LC-D OM3 aqua, 2.0 m

Page 1/5

P/N
13PJ1JOJO20-E
EAN 4250184100010

2018-13-03

Illustrations

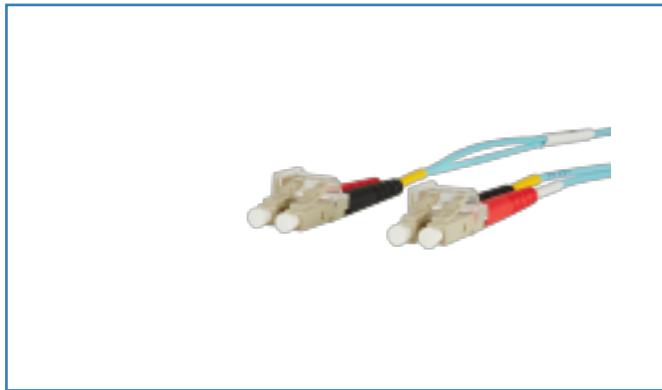

Dimensional drawing

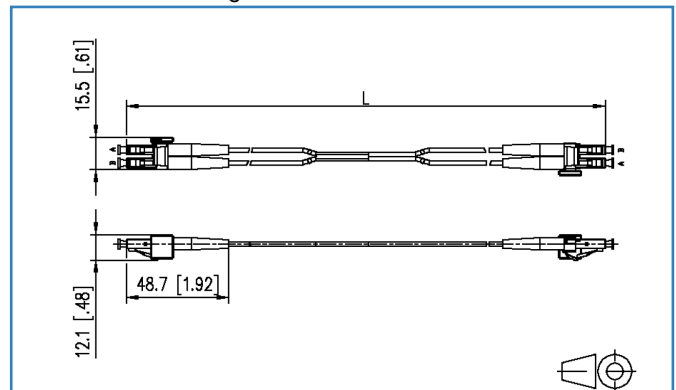

See enlarged drawings at the end of document

Product specification

- patch cord for the METZ CONNECT Patch Management System
- multi mode patch cord I-V(ZN)H 50/125 OM3
- laser-optimized, bend insensitive multi mode fiber OM3, G50/125 μm to IEC 60793-2-10 type A1a.2
- outer diameter 2.0 x 4.2 mm
- halogen-free sheath material with low smoke development LSHF-FR, flame retardant
- duplex cord as zip-cord (figure 8) with two tight buffered fibers and aramide as strain relief
- machine polished front face
- 100 % tested
- colors may slightly vary due to production lots
- maximum length 20 m
- available in various lengths – replace xx in the part number by the desired length as follows: 10 = 1.0 m; 20 = 2.0 m; 50 = 5.0 m; A0 = 10 m; B0 = 20 m
- both connectors feature an integrated RFID tag, pre-configured to highlight its ID, length, color, type and performance class
- RFID tag to ISO/IEC 15693



Technical Data

General Data

Fields of application	Structured building cabling, Office Data center, METZ CONNECT Patch Management System
Design	Patch cords
Transmission technology	Fiber optic
Wiring	crossed
Color	aqua
Dimensions	
Dimension - Interface 1 (L x W x H)	48.70 x 15.50 x 12.10 mm
Dimension - Interface 1 (L x W x H)	1.917 x 0.61 x 0.476 in.
Dimension - Interface 2 (L x W x H)	48.70 x 15.50 x 12.10 mm
Dimension - Interface 2 (L x W x H)	1.917 x 0.61 x 0.476 in.
Mode type of the fiber	Multimode
Fiber class	OM3: ISO/IEC 11801/EN 50173 & IEC 60793-2-10/EN 60793-2-10 A1.a.2
Number of cables/ cores	2
Fiber construction	50/125 µm
Cable length (m)	2.00 m
Maximum length	20.00 m
Weight	8.0 kg/km

Transmission characteristics

Reach	
Reach 100BASE	2000 m
Reach 1000BASE LX	550 m
Reach 1000BASE SX	1000 m
Reach 10GBASE LX4	300 m
Reach 10GBASE SW/SR	300 m
Reach 40GBASE SR4	100 m
Overfilled (OFL) modal bandwidth at 850 nm (min.)	1500 MHz * km
Overfilled (OFL) modal bandwidth at 1300 nm (min.)	500 MHz * km
Effective modal bandwidth (EMB) at 850 nm (min.)	2000 MHz * km



Technical Data

Connections/interfaces

Connector technology interface 1	LC-D PC
Connector technology interface 2	LC-D PC
RFID-Tag	both sides
Ferrule diameter	1.25 mm
Ferrule diameter	0.049 in.

Optical characteristics

Insertion loss	max. 0.4 dB
Return loss	min. 35 dB

Mechanical characteristics

Life - Number of mating cycles	min. 1000
strain relief	aramide fibres
Short term tensile strength	70 N
Minimum bending radius	7.50 mm
Minimum bending radius	0.295 in.

Materials and material properties

Bend insensitivity	yes
Flame retardancy	yes
Halogen free	yes

Environmental conditions

Temperature (min. - max.)	
Temperature - Operating °C	-10 - 60 °C
Temperature - Operating °F	14 - 140 °F

Approvals

RoHS	compliant
------	-----------



Technical Data

The product meets the following standards

Generic cabling systems

General requirements	ISO/IEC 11801
----------------------	---------------

Fibre optic connector interfaces	IEC 61754-20
----------------------------------	--------------

Optical fibers: Product specifications

Sectional specification for category A1 multimode fibres	ISO/IEC 60793-2-10 (A1a.2)
--	----------------------------

Test on gases evolved during combustion of materials from cables

Determination of acidity (by measuring the pH value) and conductivity	IEC 60754-2
---	-------------

Tests on electric and optical fibre cables under fire conditions

Test for vertical flame propagation for a single insulated wire or cable	ISO/IEC 60332-1-2
--	-------------------

Measurement of smoke density of cables burning	ISO/IEC 61034-2
--	-----------------

Vicinity Integrated Circuit Cards (VICC)	RFID-Tag according to ISO/IEC 15693 1¼m
--	---

Packing details

Type of packaging	1 pc(s) / plastic bag
-------------------	-----------------------

Packaging unit - Weight (gram)	28.00 g
--------------------------------	---------

Packaging unit - Weight (pound)	0.06 lb
---------------------------------	---------

Illustrations

Dimensional drawing

