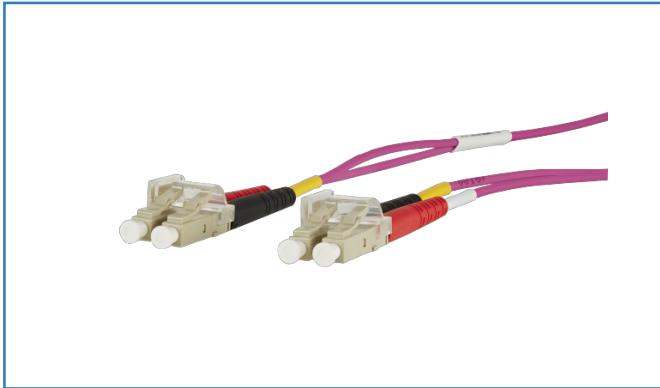

Data sheet**PM PCC OpDAT patch cord LC-D/LC-D OM4 violet, 5.0 m**

Page 1/5

P/N
13PS1JOJO50-E
EAN 4251122197246

2018-13-03

Illustrations

Dimensional drawing

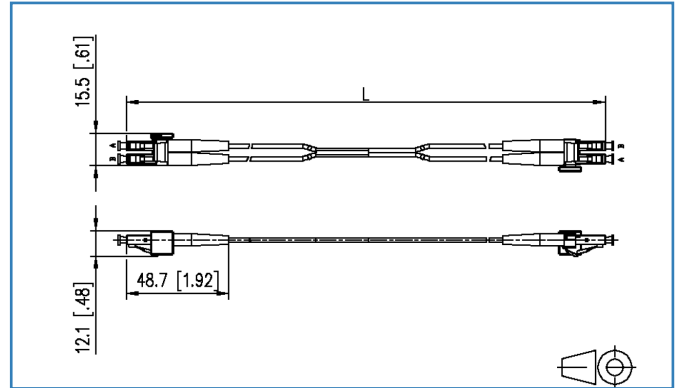

See enlarged drawings at the end of document



PM PCC OpDAT patch cord LC-D/LC-D OM4 violet, 5.0 m

P/N
13PS1JOJO50-E
EAN 4251122197246

2018-13-03

Technical Data

General Data

Fields of application	Structured building cabling, Office Data center, METZ CONNECT Patch Management System
Design	Patch cords
Transmission technology	Fiber optic
Wiring	crossed
Color	violet
Dimensions	
Dimension - Interface 1 (L x W x H)	48.70 x 15.50 x 12.10 mm
Dimension - Interface 1 (L x W x H)	1.917 x 0.61 x 0.476 in.
Dimension - Interface 2 (L x W x H)	48.70 x 15.50 x 12.10 mm
Dimension - Interface 2 (L x W x H)	1.917 x 0.61 x 0.476 in.
Mode type of the fiber	Multimode
Fiber class	OM4: ISO/IEC 11801/EN 50173 & IEC 60793-2-10/EN 60793-2-10 A1.a.3
Number of cables/ cores	2
Fiber construction	50/125 µm
Cable length (m)	5.00 m
Maximum length	20.00 m
Weight	8.0 kg/km

Transmission characteristics

Reach	
Reach 100BASE	2000 m
Reach 1000BASE LX	550 m
Reach 1000BASE SX	1000 m
Reach 10GBASE LX4	300 m
Reach 10GBASE SW/SR	300 m
Reach 40GBASE SR4	100 m
Overfilled (OFL) modal bandwidth at 850 nm (min.)	1500 MHz * km
Overfilled (OFL) modal bandwidth at 1300 nm (min.)	500 MHz * km
Effective modal bandwidth (EMB) at 850 nm (min.)	2000 MHz * km



Technical Data

Connections/interfaces

Connector technology interface 1	LC-D PC
Connector technology interface 2	LC-D PC
RFID-Tag	both sides
Ferrule diameter	1.25 mm
Ferrule diameter	0.049 in.

Optical characteristics

Insertion loss	max. 0.4 dB
Return loss	min. 35 dB

Mechanical characteristics

Life - Number of mating cycles	min. 1000
strain relief	aramide fibres
Short term tensile strength	70 N
Minimum bending radius	7.50 mm
Minimum bending radius	0.295 in.

Materials and material properties

Bend insensitivity	yes
Flame retardancy	yes
Halogen free	yes

Environmental conditions

Temperature (min. - max.)	
Temperature - Operating °C	-10 - 60 °C
Temperature - Operating °F	14 - 140 °F

Approvals

RoHS	compliant
------	-----------



Technical Data

The product meets the following standards

Generic cabling systems

General requirements	ISO/IEC 11801
----------------------	---------------

Fibre optic connector interfaces	IEC 61754-20
----------------------------------	--------------

Optical fibers: Product specifications

Sectional specification for category A1 multimode fibres	ISO/IEC 60793-2-10 (A1a.2)
--	----------------------------

Test on gases evolved during combustion of materials from cables

Determination of acidity (by measuring the pH value) and conductivity	IEC 60754-2
---	-------------

Tests on electric and optical fibre cables under fire conditions

Test for vertical flame propagation for a single insulated wire or cable	ISO/IEC 60332-1-2
--	-------------------

Measurement of smoke density of cables burning	ISO/IEC 61034-2
--	-----------------

Vicinity Integrated Circuit Cards (VICC)	RFID-Tag according to ISO/IEC 15693 1¼m
--	---

Packing details

Type of packaging	1 pc(s) / plastic bag
-------------------	-----------------------

Packaging unit - Weight (gram)	52.00 g
--------------------------------	---------

Packaging unit - Weight (pound)	0.11 lb
---------------------------------	---------



Illustrations

Dimensional drawing

