

## Data sheet

### PM PIC OpDAT patch cord LC-D/LC-D OM4 violet, 5.0 m

Page 1/5

P/N  
13PS1JOJO501E  
EAN 4251122197291

2018-13-03

## Illustrations

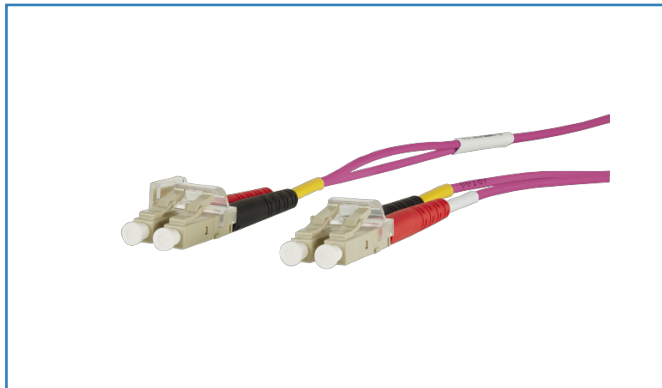

Dimensional drawing

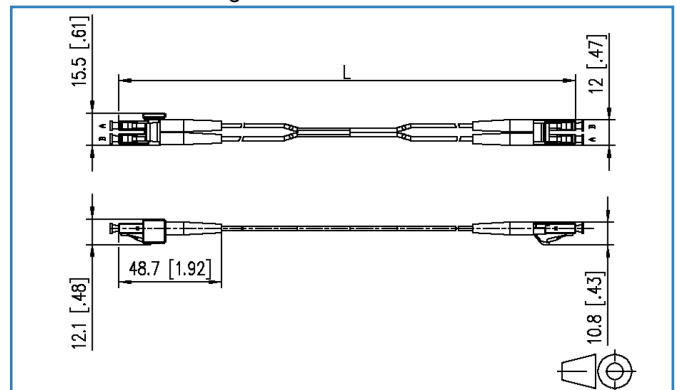

See enlarged drawings at the end of document

## Product specification

- patch cord for the METZ CONNECT Patch Management System
- multi mode patch cord I-V(ZN)H 50/125 OM4
- laser-optimized, bend insensitive multi mode fiber OM4, G50/125  $\mu\text{m}$  to IEC 60793-2-10 type A1a.2
- outer diameter 2.0 x 4,2 mm
- halogen-free sheath material with low smoke development LSHF-FR, flame retardant
- duplex cord as zip-cord (figure 8) with two tight buffered fibers and aramide as strain relief
- machine polished front face
- 100 % tested
- colors may slightly vary due to production lots
- maximum length 20 m
- available in various lengths &ndash; replace xx in the part number by the desired length as follows: 10 = 1.0 m; 20 = 2.0 m; 50 = 5.0 m; A0 = 10 m; B0 = 20 m
- one connector features an integrated RFID tag, pre-configured to highlight its ID, length, color, type and performance class
- RFID tag to ISO/IEC15693



## Technical Data

### General Data

Fields of application	Structured building cabling, Office Data center, METZ CONNECT Patch Management System
Design	Patch cords
Transmission technology	Fiber optic
Wiring	crossed
Color	violet
Dimensions	
Dimension - Interface 1 (L x W x H)	48.70 x 15.50 x 12.10 mm
Dimension - Interface 1 (L x W x H)	1.917 x 0.61 x 0.476 in.
Dimension - Interface 2 (L x W x H)	48.70 x 12.00 x 10.80 mm
Dimension - Interface 2 (L x W x H)	1.917 x 0.472 x 0.425 in.
Mode type of the fiber	Multimode
Fiber class	OM4: ISO/IEC 11801/EN 50173 & IEC 60793-2-10/EN 60793-2-10 A1.a.3
Number of cables/ cores	2
Fiber construction	50/125 µm
Cable length (m)	5.00 m
Maximum length	20.00 m
Weight	8.0 kg/km

### Transmission characteristics

Reach	
Reach 100BASE	2000 m
Reach 1000BASE LX	550 m
Reach 1000BASE SX	1000 m
Reach 10GBASE LX4	300 m
Reach 10GBASE SW/SR	300 m
Reach 40GBASE SR4	100 m
Overfilled (OFL) modal bandwidth at 850 nm (min.)	1500 MHz * km
Overfilled (OFL) modal bandwidth at 1300 nm (min.)	500 MHz * km
Effective modal bandwidth (EMB) at 850 nm (min.)	2000 MHz * km



## Technical Data

### Connections/interfaces

Connector technology interface 1	LC-D PC
Connector technology interface 2	LC-D PC
RFID-Tag	on one side
Ferrule diameter	1.25 mm
Ferrule diameter	0.049 in.

### Optical characteristics

Insertion loss	max. 0.4 dB
Return loss	min. 35 dB

### Mechanical characteristics

Life - Number of mating cycles	min. 1000
strain relief	aramide fibres
Short term tensile strength	70 N
Minimum bending radius	7.50 mm
Minimum bending radius	0.295 in.

### Materials and material properties

Bend insensitivity	yes
Flame retardancy	yes
Halogen free	yes

### Environmental conditions

Temperature (min. - max.)	
Temperature - Operating °C	-10 - 60 °C
Temperature - Operating °F	14 - 140 °F

### Approvals

RoHS	compliant
------	-----------

### Technical Data

#### The product meets the following standards

##### Generic cabling systems

General requirements	ISO/IEC 11801
----------------------	---------------

Fibre optic connector interfaces	IEC 61754-20
----------------------------------	--------------

##### Optical fibers: Product specifications

Sectional specification for category A1 multimode fibres	ISO/IEC 60793-2-10 (A1a.2)
--	----------------------------

##### Test on gases evolved during combustion of materials from cables

Determination of acidity (by measuring the pH value) and conductivity	IEC 60754-2
---	-------------

##### Tests on electric and optical fibre cables under fire conditions

Test for vertical flame propagation for a single insulated wire or cable	ISO/IEC 60332-1-2
--	-------------------

Measurement of smoke density of cables burning	ISO/IEC 61034-2
--	-----------------

Vicinity Integrated Circuit Cards (VICC)	RFID-Tag according to ISO/IEC 15693 1¼m
--	---

#### Packing details

Type of packaging	1 pc(s) / plastic bag
-------------------	-----------------------

Packaging unit - Weight (gram)	50.00 g
--------------------------------	---------

Packaging unit - Weight (pound)	0.11 lb
---------------------------------	---------



## Illustrations

Dimensional drawing

