

Data sheet

E-DAT Industry patch cord V6 IP67 - RJ45 2.0 m

Page 1/6

P/N

141N113K10020

EAN 4250184131328

2017-28-11

Illustrations



Dimensional drawing

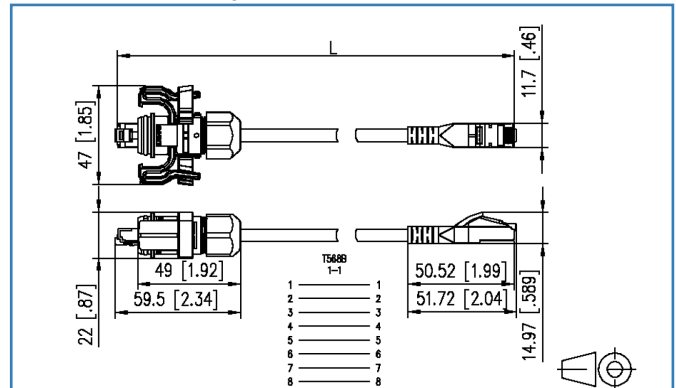

See enlarged drawings at the end of document

Product specification

- fully shielded Cat.6 patch cable AWG 26/7 S/FTP with PUR cable sheath
- 1 x RJ45 and 1 x RJ45-IP67-V6 connector, shielded
- 1:1 assignment
- compliance with class E to ISO/IEC 11801 Ed.2.2:2011-06, DIN EN 50173-1:2011-09
- yellow cable, gray connector
- cable colors may differ
- other lengths available
- variants: 1, 2, 3, 5, 10, 15 and 20 m

Technical Data

General Data

Fields of application	Industrial Ethernet
Design	patch cord
Shielding	shielded
Transmission technology	Copper
Cable Type	S/FTP
Number of twisting elements	4
Twisting element	Pair
Wiring	1 - 1
Color	yellow
Dimensions	
Dimension - Interface 1 (L x W x H)	51.72 x 11.70 x 14.97 mm
Dimension - Interface 1 (L x W x H)	2.036 x 0.461 x 0.589 in.
Dimension - Interface 2 (L x W x H)	59.50 x 47.00 x 22.00 mm
Dimension - Interface 2 (L x W x H)	2.343 x 1.85 x 0.866 in.
Cable length (m)	2.00 m

Transmission characteristics

Category (ISO)	6
Class (ISO/IEC)	E
PoE	IEEE 802.3af
PoE plus	IEEE 802.3at
UPoE	yes
Transmission rate up to 1 GBit (Fast Ethernet)	IEEE 802.3ab

Connections/interfaces

Connector technology interface 1	RJ45 plug
Connector technology interface 2	RJ45 plug
Number of ports interface 1	1
Number of ports interface 2	1
Number of equipped ports interface 1	1
Number of ports interface 2 equipped	1
Number of positions/contacts interface 1	8P/8C
Number of positions/contacts interface 2	8P/8C
Protective housing interface 2	V6

Technical Data

Connections/interfaces

Termination data, stranded wire (min. - max.)

Conductor cross section, stranded wire	AWG 26/7
Conductor cross section, stranded wire	0.141 mm ²
Conductor diameter, stranded wire (bare copper)	0.483 mm
Conductor diameter, stranded wire (bare copper)	0.019 in.
Cable sheath diameter (min. - max.)	
Cable sheath diameter	5.8 mm
Cable sheath diameter	0.228 in.

Electrical characteristics

Contact resistance	max. 20 mOhm
Insulation resistance	min. 500 MOhm

Mechanical characteristics

Life - Number of mating cycles	min. 750
Position/mounting of latch - standard installation position	top
Bending radius without load	17.4 mm
Bending radius without load	0.685 in.
Bending radius with load	46.4 mm
Bending radius with load	1.827 in.

Materials and material properties

Material - Conductor	Cu (copper)
Material - Conductor Insulation	Foam-Skin Polyethylen
Material - Cable jacket	PUR
Material - Plug housing interface 1	PC UL94 V0
Material - Plug housing interface 2	PC UL94 V0
Material - Protective housing interface 1	PA 6.6 UL94 V0
Material - Contact interface 1	Ph-Br (Phosphor Bronze)
Material - Contact interface 2	Ph-Br (Phosphor Bronze)
Material - Contact finish interface 1	Ni + Au (nickel-gold)
Material - Contact finish interface 2	Ni + Au (nickel-gold)
Material - Protective housing interface 1	PA 6.6 UL94 V0
Flame retardancy	yes



Technical Data

Materials and material properties

Halogen free	yes
Oil resistance	yes

Environmental conditions

Temperature (min. - max.)	
Temperature - Operating °C	-20 - 60 °C
Temperature - Operating °F	-4 - 140 °F
Temperature - Installation °C	0 - 50 °C
Temperature - Installation °F	32 - 122 °F
Particulate ingress interface 2	IP6X when plugged in
Liquid ingress/immersion interface 2	IPX7 when plugged in

Approvals

RoHS	compliant
------	-----------

The product meets the following standards

Generic cabling systems	
General requirements	ISO/IEC 11801 Ed.2.2:2011-06 DIN EN 50173-1:2011-09
Test for vertical flame propagation for a single insulated wire or cable	IEC 60332-1
Measurement of smoke density of cables burning	IEC 61034
Determination of acidity (by measuring the pH value) and conductivity	IEC 60754-2

Classifications

ETIM 5.0	EC001262
ETIM 6.0	EC001262

Packing details

Type of packaging	1 pc(s) / plastic bag
Packaging unit - Weight (gram)	68.00 g
Packaging unit - Weight (pound)	0.15 lb



Accessories

P/N	Designation
130906-V3-I	Locking clamp for IP67 V6 plug, light gray
130906-V5-I	Locking clamp for IP67 V6 plug, yellow
130906-V6-I	Locking clamp for IP67 V6 plug, blue
130906-V7-I	Locking clamp for IP67 V6 plug, green
130906-V8-I	Locking clamp for IP67 V6 plug, red



Illustrations

Dimensional drawing

